

8M SQUARE POLE

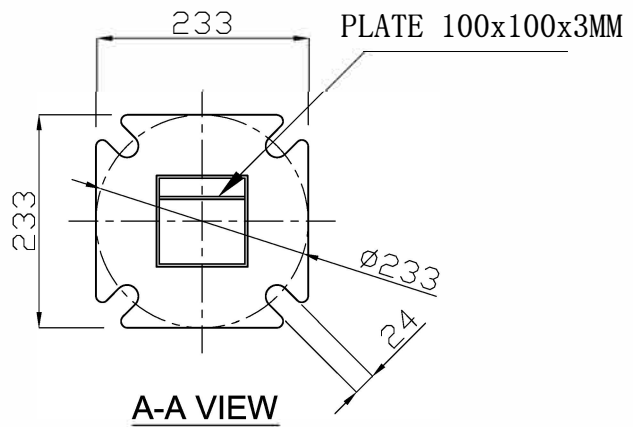

NOTES:

1. MATERIAL: Q235; WALL THICKNESS=3MM.
2. SURFACE FINISH: POWDER COATED AFTER HOT DIP GALVANIZATION.
3. ALL DIMENSIONS ARE IN MILLIMETER.

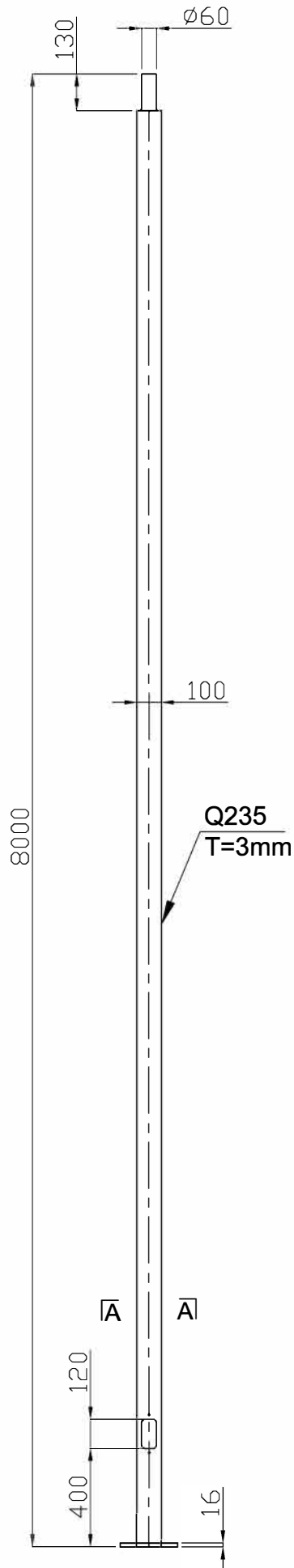

HOGAN LED PROFILES

www.hoganledprofiles.com

PRODUCT		8M SQUARE POLE			
PROJECT		Quantity		Drawing NO.	
Designed	S.M.	Date	G.W.(kg)	HLP800-SQ	
Checked	B.S.D.	Date	Material:		
Approved	G.W.	Date	Feb	Q235	